

Tron TR20 GMDSS





www.jotron.com

Amendment Records

AMEND- MENT NO.	INCORP. BY	DATE	PAGE(S)	VERSION	REASON FOR CHANGE
1		10.09.03	10	D	EM4038
2		04.03.04	1-5, 8, 10	E	EM4197
3	ES	03.10.06	56 total	F	CN 05309
4	ES	18.04.07	56 total	G	New company name and logo
5	ES	27.06.07	Total: 52	H	New antenna Removed PLUS
6	ES	03.02.09	44 and 45	I	Updated text
7	TH	03.03.09	40 total	J	New layout
8	TH	18.06.10	33 and 34	K	Updated text
9	TH	06.04.11	11	L	Updated distress guidance
10					
11					
12					
13					
14					
15					
16					



www.jotron.com

EC Declaration of Conformity, available at www.jotron.com

Read this Users Manual fully to familiarise yourself with the equipments functions and facilities.

Abbreviations and definitions

CLOCK

A precisely spaced, stable train of pulses generated within an electronic system to synchronize the timing of digital operations within the system.

DEFAULT

A condition that the navigator assumes automatically if no other condition is initiated by the operator.

DW

Dual Watch. Receiver altering between two different channels.

GMDSS

Global Maritime Distress & Safety System

IEC

International Electro-technical Commission.

IMO

International Maritime Organization

IP rating

Joint factor (to indicate the waterproofing of the equipment)



www.jotron.com

ITU

International Telecommunication Union.

LED

Light Emitting Diode.

SMA

SubMiniature version A connector

TW

Triple Watch. Receiver altering between three different channels.

VHF

Very High Frequency - A set of frequencies in the MHz region.

VSWR

Voltage standing wave ratio



www.jotron.com

The information in this book has been carefully checked and is believed to be accurate. However, no responsibility is assumed for inaccuracies.



CAUTION!

This equipment contains CMOS integrated circuits. Observe handling precautions to avoid static discharges which may damage these devices. Jotron AS reserves the right to make changes without further notice to any products or modules described herein to improve reliability, function or design. Jotron AS does not assume any liability arising out of the application or use of the described product.



TABLE OF CONTENTS

1	General description	13
1.1	Introduction	13
1.2	Features	13
1.3	Licensing	14
1.4	Getting started	14
2	Technical specification	15
2.1	General	15
2.2	Receiver	15
2.3	Transmitter	15
2.4	Charger	15
3	Functional description	16
3.1	Radio unit	16
3.2	Antenna	17
3.3	Battery removal and replacement	17
3.4	Primary battery	17
	3.4.1 Description	17
	3.4.1.1 When to change battery	17
3.5	Secondary battery and charger	18
	3.5.1 Using the nimh battery	18
	3.5.2 Charging the secondary battery	18
	3.5.3 Battery endurance	19
4	Installation	20



www.jotron.com

5	Operating instructions	20
5.1	Configuring the TR20	20
5.2	Menu flowchart	21
5.2.1	Standard screen	22
5.2.2	Key lock	22
5.3	Function keys	23
5.4	Channel 16	23
5.5	Main menu	25
5.5.1	Contrast	25
5.5.2	Single / DW / TW	26
5.5.3	Key tone	29
5.5.4	Info	29
5.5.5	Battery selection	29
6	Maintenance and troubleshooting	31
6.1	How to take care of your TR20	31
6.2	Regular test procedure	31
6.3	Cleaning of dirt and oil	32
6.4	Service and warranty	32
6.5	Guide to troubleshooting	33
7	Maritime VHF channels	35
8	Practical use, VHF transmission range	37
9	Spare parts and accessories	38
10	Service agents	39



www.jotron.com

BATTERY SAFETY DATA SHEET

(Form: EEC directive 91/155)

(2) SAFETY ADVICE

- S2 Keep out of reach from children.
- S8 Keep container dry.
- S26 In case of contact with eyes, rinse immediately with plenty of water and seek medical advice.
- S43 In case of fire, use D type extinguishers. Never use water.
- S45 In case of accident or if you feel unwell, seek medical advice immediately (show the label where possible).

(3) FIRST AID MEASURES

In case of contact of cell contents with eyes, flush immediately with water for 15 min. With skin, wash with plenty of water and take off contaminated clothes. If inhalation, remove from exposure, give oxygen, seek medical advice.

(4) FIRE-FIGHTING MEASURES

Extinguishing media

Suitable: Type D fire extinguishers

Not to be used: Water - CO₂ - Halon, dry chemical or foam extinguishers



www.jotron.com

Special exposure hazards

Generation of chlorine, sulfur dioxide, disulfur dichloride during thermal decomposition.

Special protective equipment

Use protective working boots, rubber apron and safety glasses with side shields.

INSTRUCTIONS FOR KEEPING THE RADIO LOG AND THE RADIO OPERATORS OBLIGATION ACCORDING TO NATIONAL AND INTERNATIONAL REGULATION.

1. The radio log shall be kept in accordance with requirements in the Radio Regulations, SOLAS Convention, national regulations regarding radio installations and the STCW Convention (STCW 95 including the STCW Code) including relevant regulation regarding watch keeping on board passenger- and cargo ships.
2. Unauthorized transmissions and incidents of harmful interference should, if possible, be identified, recorded in the radio log and brought to the attention of the Administration in compliance with the Radio Regulations, together with an appropriate extract from the radio log. (STCW Code B-VIII/2 No.32)

TEST OF RADIO EQUIPMENT AND RESERVE SOURCE OF ENERGY

Weekly:

GMDSS handheld VHF transceivers to be tested without using the mandatory required emergency batteries.



www.jotron.com

GUIDANCE ON DISTRESS ALERTS

on VHF without DSC

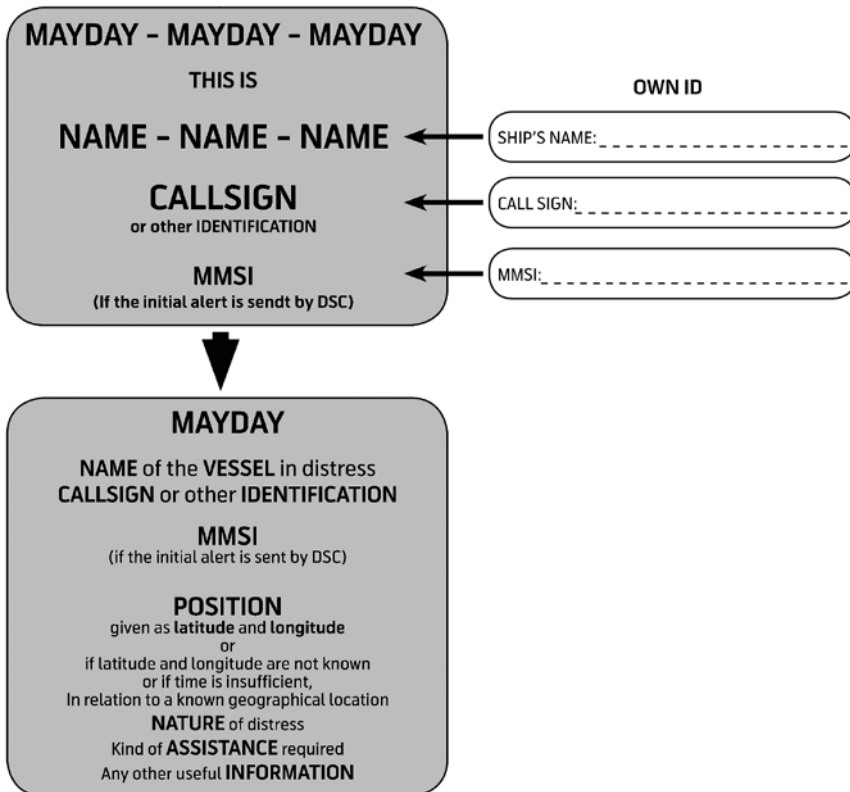



www.jotron.com

Write down the distress message. Speak slowly and distinctly.

A	Alfa	P	Papa
B	Bravo	Q	Quebec
C	Charlie	R	Romeo
D	Delta	S	Sierra
E	Echo	T	Tango
F	Foxtrot	U	Uniform
G	Golf	V	Victor
H	Hotel	W	Whiskey
I	India	X	X-ray
J	Juliett	Y	Yankee
K	Kilo	Z	Zulu
L	Lima	Æ	Ægir
M	Mike	Ø	Ørnulf
N	November	Å	Ågot
O	Oscar		



www.jotron.com

1 GENERAL DESCRIPTION

1.1 INTRODUCTION

Tron TR20 GMDSS (hereafter named as TR20) is specially designed for GMDSS applications. It conforms to ETS 300 225 standard and is waterproof to IP67. The housing is made from glass-reinforced polycarbonate in a highly visible colour.

1.2 FEATURES

Watertight

TR20 is watertight to a depth of 1 metre (IP67).

Rugged design

TR20 is made to resist a drop from 1 metre onto a hard surface. It is also resistant to seawater, oil and sunlight.

Handling

TR20 is made for easy operation, with a brief operating instruction printed on the rear. It is possible to fully operate TR20 with one hand, even when wearing gloves. Both display and keys have integrated backlighting to ease operation in low light conditions.

Housing

TR20 is of small size (62mm x 160mm x 41mm), and has no sharp edges to damage raft or clothing. Belt clip is standard, wrist strap (standard for GMDSS) and carrier case are available options.

Low power consumption

TR20 has low power consumption and with transmit, receive and standby ratio of 1: 1: 8 the battery lifetime is exceeding 12 hours with Lithium battery.



www.jotron.com

Graphical display

TR20 is equipped with a high contrast graphical display with built in backlight for clear indication of the radios settings.

Service

Handheld VHF service is available through the Jotron AS worldwide service network. See details on www.jotron.com.

1.3 LICENSING

Prior to use please check your national requirements for the operators of VHF radios and also that your radio will conform to local regulations before use.

Regulations for VHF radios may vary from country to country.

1.4 GETTING STARTED

Congratulation on your TR20 purchase.

To ensure this unit gives trouble free performance from the outset, please adhere to the following safeguards:

Connect the antenna before use and charge the battery fully before connecting to the equipment.

Follow this manuals menu selection and set the battery option being used on the equipment to ensure the battery state indicator gives a true reading.

Follow the menu selection and set the squelch such that the background noise just disappears when in receive mode.

Follow the menu selection and adjust the contrast on the display to a level giving good contrast.



www.jotron.com

2 TECHNICAL SPECIFICATION

2.1 GENERAL

Frequency range:	154 – 163 MHz
Channel spacing:	25kHz
Operating temperature range:	-20 to +55°C.
Battery life:	> 12 hours (Lithium battery, 2W power output, 10-10-80 @ -20°C). > 11 hours (1500mAh NiMH battery, 5W power output, 5-5-90 @ +20°C).
Size, WHD:	62mm x 160mm x 41mm
Weight:	Approx. 420g with NiMH battery Approx. 350g with Lithium battery

2.2 RECEIVER

Maximum usable sensitivity:	< 1 μ V for 20dB SINAD
Adjacent channel rejection:	> 70dB
Blocking:	> 90dB
Spurious response:	> 70dB
Harmonic distortion:	< 5%
Intermodulation rejection:	> 68dB

2.3 TRANSMITTER

RF output power:	1W (Lo) / 2 W (Hi)
Harmonics and spurious:	< 0.25 μ W
Frequency error:	< +1.5kHz
Adjacent channel power:	< -70dBc

2.4 CHARGER

Dual slot fast charger with trickle charging. Operates on 12 –24 DC, or 115/230VAC with external mains adapter. Wall and table mountable.	
Size, WHD:	155mm x 69mm x 83mm
Weight:	Approx. 300g



www.jotron.com

3 FUNCTIONAL DESCRIPTION

3.1 RADIO UNIT

- 1 PTT (Push To Talk)
- 2 Up
- 3 Menu
- 4 Channel
- 5 High / Low power
- 6 Channel 16
- 7 Battery release
- 8 ON / OFF
- 9 Down
- 10 Squelch
- 11 Enter DW/TW
- 12 N/A
- 13 Antenna



Figure 3.1 Location of controls and facilities of the TR20



3.2 ANTENNA

The antenna for TR20 is fitted with a standard SMA connector. A remote antenna can be connected for fixed applications.

3.3 BATTERY REMOVAL AND REPLACEMENT

To release the battery, press both battery release clips and gently pull the battery away from the radio.

To replace the battery, slide the battery into position, and make sure the battery clips fully engage.

Note! The radio is not watertight without the battery in place!

3.4 PRIMARY BATTERY

3.4.1 DESCRIPTION

The primary battery unit is a 9V / 2900mAh lithium battery. This unit is specially designed for GMDSS emergency use to preserve a long shelf- and operating-life. This battery cannot be recharged.

Type no. of battery: 80060
Colour: Orange

3.4.1.1 WHEN TO CHANGE BATTERY

Replace the lithium battery before expiry date. The lithium battery pack has a shelf life of 5 years. If TR20 is indicating low voltage during normal use, the lithium battery will have to be replaced. Please refer to chapter 3.4 for battery replacement.



Figure 3.4 Battery release



www.jotron.com

To prevent the possibility of being in an emergency situation with a TR20 equipped with a used battery, we strongly recommend storing an extra battery, in lifeboats and rafts. Store this battery without breaking the sealing.

Special care

The primary battery is of a high-energy lithium type, and some precautions must be taken. Do not heat above 70°C, recharge, crush, disassemble or incinerate. This may result in fire, explosion and severe burn hazard.

Do not throw used batteries overboard, but return them to your local dealer.

3.5 SECONDARY BATTERY AND CHARGER

3.5.1 USING THE NiMH BATTERY

TR20 can be delivered with a rechargeable NiMH battery. This battery has a capacity of 7.2V / 1500mAh. The battery is supplied uncharged and must be charged before use.

Type no. of battery: 80059
Colour: Dark grey

After recharging the battery, it can be used in the same way as the primary battery unit. The battery condition indicator on the main display shows the approximate status of the battery's charging condition, and will indicate when it is time for recharging.

Please refer to chapter 3.4 for battery replacement.

3.5.2 CHARGING THE SECONDARY BATTERY

The charger RCH-20 is a dual slot quick charger. The charger will accept a complete radio or the battery alone (see fig. 3.6.2). If two batteries are present, the charger will automatically start fast charging the second battery



when the first battery is fully charged. The first battery will then be trickle charged to keep it fully charged.

The charger will charge a fully discharged battery in approx. 3.5 hours.

Figure 3.6.2 TR20 and single battery in charger.



3.5.3 BATTERY ENDURANCE

Battery type	Standby time (H)	5:5:90 (H) Tx:Rx:Standby		10:10:80 (H) Tx:Rx:Standby
		1W	2W	
Lithium, 2900mAh	70	34	25	12 *
NiMH, 1500mAh	38	19	14	

* 2W at -20°C , ref. GMDSS spec., all other values are approximate values at 20°C . TR20 uses 1 and 2 W.



www.jotron.com

4 INSTALLATION

- Connect the antenna before use and charge the battery fully before connecting to the equipment.
- Follow this manual's menu selection and set the battery option being used on the equipment to ensure the battery state indicator gives a true reading.
- Follow the menu selection and set the squelch such that the background noise just disappears when in receive mode.
- Place the radio and charger in a spot away from direct sea spray, chemicals, oil, exhaust and vibrations.
- The location must also be easily accessible for testing and maintenance.

5 OPERATING INSTRUCTIONS

5.1 CONFIGURING THE TR20

The operation of TR20 is based on function keys and menus. The display indicates the chosen function by an arrow. To return to standard screen after operating the function keys, press "Enter"(11). To return to standard screen after entering the menus, press Menu"(3).





5.2 MENU FLOWCHART

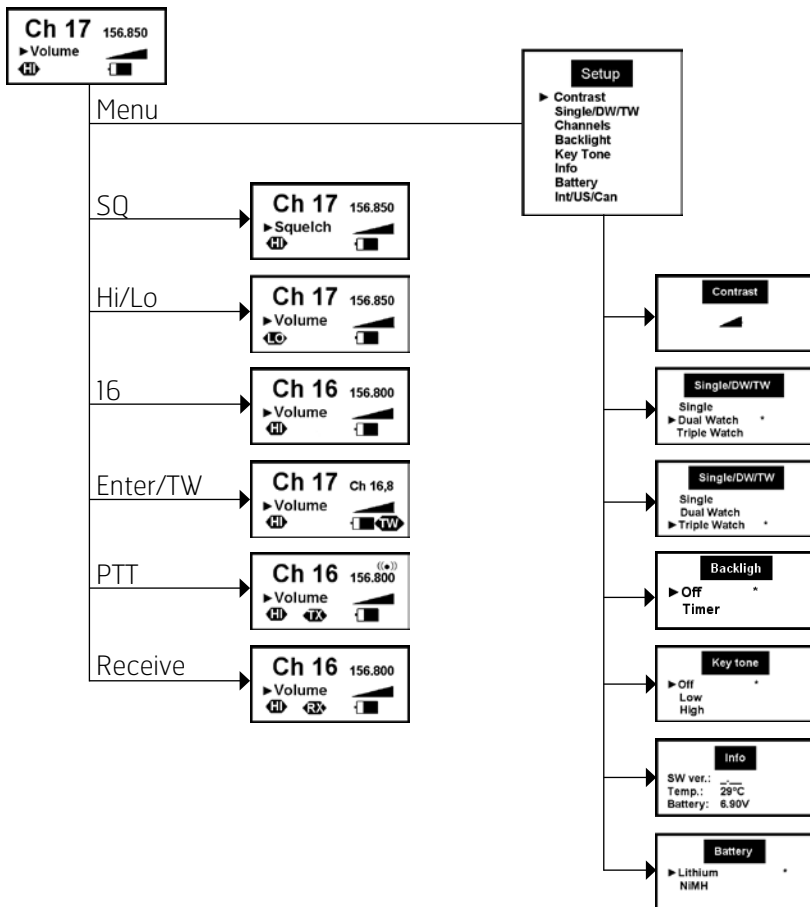



www.jotron.com

5.2.1 STANDARD SCREEN

This is the standard/default screen for the TR20. The display returns to this mode after a break of more than 10 sec. In this mode the arrow buttons (2 & 9) adjusts the volume and the display gives a graphical volume indication. The selected channel is indicated with channel number and frequency. The condition of the battery is indicated graphically at the top of the display and the symbol "HI" indicates that the transmitter is set to high output power.

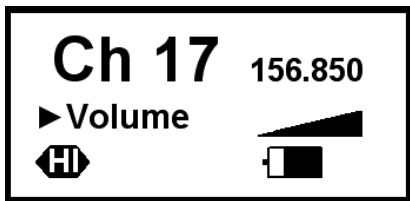

5.2.2 KEY LOCK

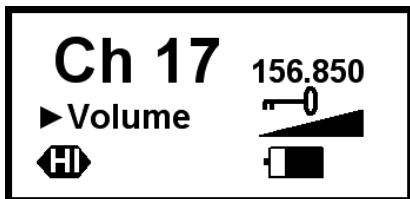

To prevent accidental operation of the keypad, the unit is equipped with a key lock. To enable the key lock, press «Menu» (3) and «Up» (2) simultaneously and hold for 1 sec. The same sequence will unlock the keys. When the key lock is activated a key symbol is seen on the display .

Note: The «PTT» key will function even if the key lock is enabled.



www.jotron.com

5.3 FUNCTION KEYS

Channel selection - CH

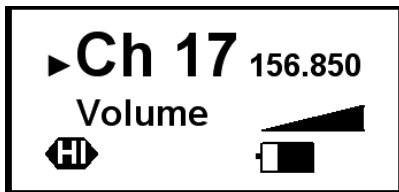

To select the working channel, press the button "CH"(4). The channel is selected by pressing the arrow buttons (2 & 9).

Squelch - SQ

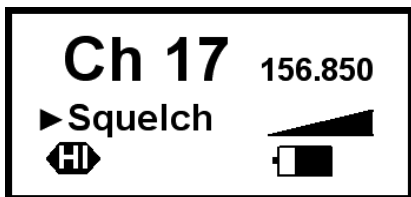

To adjust the squelch level, press the button "SQ"(10). The level is adjusted by pressing the arrow buttons (2 & 9), and the display gives a graphical indication of the level.

High and low output - Hi/Lo

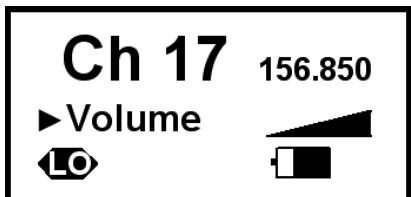

The «Hi/Lo»(5) button select between high and low output. When high output is selected «HI» is indicated on the display. When low output is selected «Lo» is written on the same position.



www.jotron.com

5.4 CHANNEL 16

By pressing the red "16"(6) key, the TR20 will enter channel 16. When on channel 16, PTT will function even if the key lock is enabled.

TX

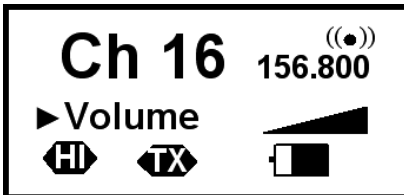

Default display on TR20 during transmit.

RX

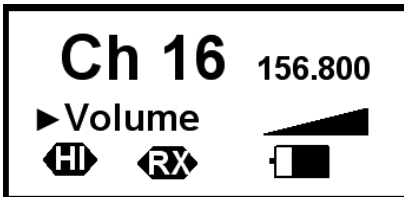

When the TR20 receive a signal the symbol "RX" is indicated in the display



www.jotron.com

5.5 MAIN MENU

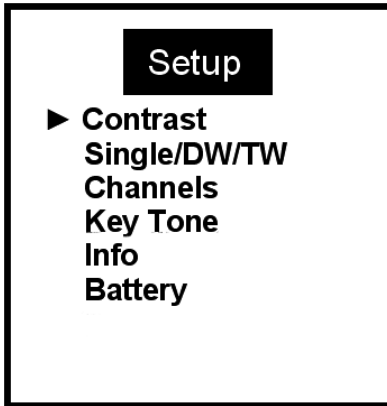

When the "Menu"(3) key is pressed the operator has access to the main menu.

The menu will scroll when pressing the arrow keys (2 & 9). When the arrow is pointing at the required parameter, press enter (11) to select.

To return to the standard screen press "Menu"(3).

5.5.1 CONTRAST

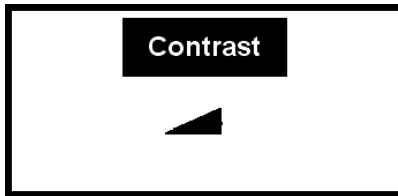

The contrast is adjusted by pressing the arrow buttons (2 & 9). The display gives a graphical indication of the level.



www.jotron.com

5.5.2 SINGLE / DW / TW

This feature enables TR20 to check for signals at one, two or three channels simultaneously.

NOTE! The receiver power consumption will increase using DW and TW.

Single means normal operation at one channel (the working channel).

Dual Watch (DW) means that the radio is listening at the working channel and at channel 16 simultaneously.

Triple Watch (TW) means that the radio is listening at the working channel, at channel 16 and at a third user selectable channel simultaneously.

The radio will always keep on listening at channel 16 independent of the received channel.

Setup of DW

Press the Menu (3) Key and select Single/DW/TW



Use the arrow keys (2 & 9) to move the cursor to DW, and press Enter (11). Press Menu (3) to return to the main display.



www.jotron.com

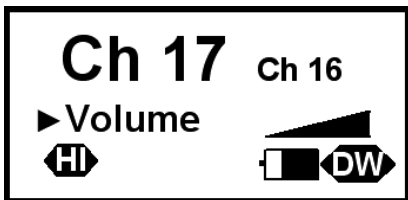

The working channel will then be displayed with large figures in the left part of the display, and channel 16 in the right part of the display.

DW will be indicated in the lower right corner of the display.

The working channel can be changed at any time by pressing the "CH" (4) key and using the arrow keys (2 & 9) to select channel and then "Enter" (11) to confirm (ref chapter 5.2).

Setup of TW

First we have to select the third watch channel. Press the Menu (3) Key and select Channels.



Use the arrow keys (2 & 9) to move the cursor to the wanted channel and press "Enter" (11) for one second to select. TW will then be displayed next to the selected channel. Press "Menu" (3) to return to the main display.



www.jotron.com

Press the Menu (3) Key and select Single/DW/TW



Use the arrow keys (2 & 9) to move the cursor to TW, and press Enter (11). Press Menu (3) to return to the main display.

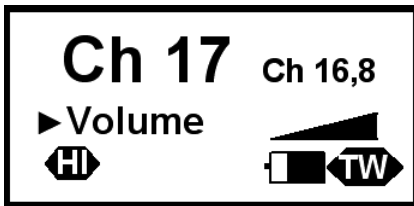

The working channel will then be displayed with large figures in the left part of the display, channel 16 and the third watch channel in the right part of the display.

TW will then be indicated in the lower right corner of the display.

The working channel can be changed at any time by pressing the “CH” (4) key and using the arrow keys (2 & 9) to select channel and then “Enter” (11) to confirm.

Switching DW/TW on and off

When double or triple watch is selected, DW or TW is turned on and off by pressing the “Enter” (11) key. When activated, “DW” or “TW” is indicated in the display. When the TR20 is in DW or TW and receives a signal, the channel number being received will be displayed on the left side of the display. If the “Enter” (11) key is pressed while receiving a signal, the TR20 will switch to single watch and be able to transmit at the same channel.

To return to the original DW/TW setup, press “Enter”(11) again.



www.jotron.com

Note! The radio is not able to transmit when it is set to double or triple watch. To transmit, DW/TW has to be turned off by pressing the “Enter”(11) key. However, if channel 16 is selected it is always possible to transmit, regardless of the DW/TW setting.

5.5.3 KEY TONE

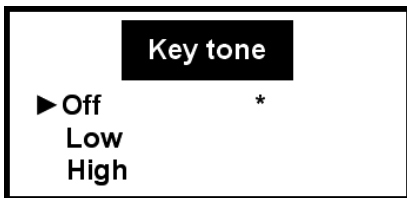

Selectable On / Off tone for key-stroke operation. High / Low describes the frequency of the tone, and not the volume.

5.5.4 INFO

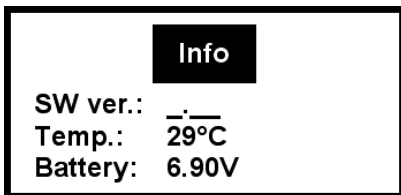

Information on software version, temperature and battery status.

5.5.5 BATTERY SELECTION

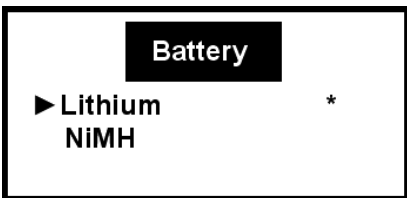

To ensure correct battery status indication, the type of battery in use must be selected.





6 MAINTENANCE AND TROUBLESHOOTING

6.1 HOW TO TAKE CARE OF YOUR TR20

TR20 is constructed to endure the rough maritime environment. Still the life is dependent on taking care of the equipment. It is a good practice to regularly inspect and test the equipment to detect error symptoms and prevent more serious problems. To keep in mind during inspection:

- If TR20 has been immersed into seawater, it is good practice to clean it in fresh water.
- Inspect battery connection pins, the gasket and the locking/release device.
- Inspect the housing for defects, which can affect the water sealing.

6.2 REGULAR TEST PROCEDURE

It is important to perform regular testing to ensure proper operation in case of a distress situation. If TR20 is used regularly, perform test every month. When TR20 is stored in a lifeboat or raft, perform test at least once a year. In order to avoid using a sealed lithium battery, we recommend keeping one battery available for this purpose.

Regular test procedure:

Step	Item	Description
1	Housing and keys	Check the housing for mechanical defects and check that all keys are in good working order.
2	Battery	Check the battery status indicator and charge or change battery if needed.
3	Transmit	Check that the TX indicator is visible when transmitting. The TX indicator indicates that carrier is produced at the antenna output.
4	Communications test	Communicate with another radiotelephone to test receive and transmit functions.



www.jotron.com

6.3 CLEANING OF DIRT AND OIL

To clean away oil and dirt from the radio, use ordinary dish-soap and water. The water temperature can be up to 45°C. Finish off by rinsing with fresh water.

6.4 SERVICE AND WARRANTY

Your radio should seldom require service or repair.

Warranty time: 2 years from factory.

Before shipping TR20 for repair, please check the fundamental procedures on operation and battery condition.

If repair is necessary please contact the nearest Jotron AS agent.

IMPORTANT!

The TR20 is a sealed waterproof radio and there are no user serviceable parts inside. It must never be opened, except by authorised Jotron AS agents. Unauthorised disassembly will invalidate the warranty.

See the next chapter for failure diagnosis. This may be of help when discussing problems with a Jotron AS agent.



6.5 GUIDE TO TROUBLESHOOTING

Troubleshooting steps:

Problem	Possible causes	Possible solutions
No indication on display	Battery is discharged.	Charge or change battery package.
You know there is a signal coming, but TR20 is not responding.	a) Squelch is muting. b) Failure in receiver.	a) Adjust squelch to 0. b) An authorised agent must service the unit.
TX indicator is on during transmitting but communication is impossible.	Use of wrong channel number.	Use same channel number as partner station.
TX indicator is not responding during transmitting	DW or TW enabled	Switch DW/TW off



www.jotron.com

Problem	Possible causes	Possible solutions
E1 is indicated on the display.	Frequency synthesizer is out of lock.	a) Try a reset by switching power OFF. b) Failure in frequency synthesizer. An authorised agent must service the unit.
E2 is indicated on the display.	Failure in transmitter	An authorised agent must service the unit.
Can `t change to desired channel	Failure in transmitter	Your sales representative can program custom channels wanted, if allowed by local authorities.
Battery indicator shows only 30% after full re-charge.	Battery indicator is set to Lithium, when NiMH battery is in use.	Change to correct battery type. See chapter 5.5.5



www.jotron.com

7 MARITIME VHF CHANNELS

Channel Designators	TX	Int. RX	USA RX	CAN RX	GMDSS channels (TR20 only)
0	156.000	156.000	156.000		
60	156.025 (*)	160.625	156.025	160.625	
1	156.050	160.650	156.050	160.650	
61	156.075	160.675	156.075	160.675	
2	156.100 (*)	160.700	156.100	160.700	
6	156.125 (*)	160.725	156.125	160.725	
3	156.150	160.750	156.150	160.750	
63	156.175	160.775	156.175	160.775	
4	156.200 (*)	160.800	156.200	160.800	
64	156.225	160.825	156.225	160.825	
5	156.250	160.850	156.250	160.850	
65	156.275	160.875	156.275	160.875	
6	156.300	156.300	156.300	156.300	*
66	156.325	160.925	156.325	160.925	
7	156.350	160.950	156.350	160.950	
67	156.375	156.375	156.375	156.375	*
8	156.400	156.400	156.400	156.400	*
68	156.425	156.425	156.425	156.425	*
9	156.450	156.450	156.450	156.450	*
69	156.475	156.475	156.475	156.475	*
10	156.500	156.500	156.500	156.500	*
70	156.525	156.525	156.525	156.525	DSC
11	156.550	156.550	156.550	156.550	*
71	156.575	156.575	156.575	156.575	*
12	156.600	156.600	156.600	156.600	*
72	156.625	156.625	156.625	156.625	*
13	156.650	156.650	156.650	156.650	*
73	156.675	156.675	156.675	156.675	*
14	156.700	156.700	156.700	156.700	*
74	156.725	156.725	156.725	156.725	*
15	156.750	156.750	156.750	156.750	*
75	-	156.775	156.775		



www.jotron.com

Channel Designators	TX	Int. RX	USA RX	CAN RX	GMDSS channels (TR20 only)
16	156.800	156.800	156.800	156.800	*
76	-	156.825	156.825		
17	156.850	156.850	156.850		*
77	156.875	156.875	156.875		*
18	156.900	161.500	156.900		
78	156.925	161.525	156.925		
19	156.950	161.550	156.950		
79	156.975	161.575	156.975		
20	157.000	161.600	161.600		
80	157.025	161.625	157.025		
21	157.050	161.650	157.050		
81	157.075	161.675	157.075		
22	157.100	161.700	157.100		
82	157.125	161.725	157.125		
23	157.150	161.750	157.150		
83	157.175	161.775	157.175		
24	157.200	161.800	161.800		
84	157.225	161.825	161.825		
25	157.250	161.850	161.850		
85	157.275	161.875	161.875		
26	157.300	161.900	161.900		
86	157.325	161.925	161.925		
27	157.350	161.950	161.950		
87	157.375	157.375	157.375		*
28	157.400	162.000	162.000		
88	157.425	157.425	157.425		*
WX01	-	-	162.550		
WX02	-	-	162.400		
WX03	-	-	162.475		
WX04	-	-	162.425		
WX05	-	-	162.450		
WX06	-	-	162.500		
WX07	-	-	162.525		

(*1) These channels are prohibited to transmit on in the USA.
The Jotron agent can insert additionally 20 national channels.



8 PRACTICAL USE, VHF TRANSMISSION RANGE

The range of VHF communications is limited to 'line of sight', because the VHF radio waves are travelling in straight lines. A higher position of the transmitter will then increase the coverage. This applies both to the receiving and transmitting end.

Some figures are indicated in the table below:

Receiver – Location 2		Transmitter – Location 1									
		Height above sea level	1 m			9 m			30 m		
			Naut. mile	Mile	Km	Naut. mile	Mile	Km	Naut. mile	Mile	Km
1 m		4.3	5	8	7-8.6	8.1-9.9	13-16	10.8-14	12.4-16.2	20-26	
9 m		7-8.6	8.1-9.9	13-16	10.8-14	12.4-16.2	20-26	24.8-29	28.5-33.4	46-53.7	
30 m		10.8-14	12.4-16.2	20-26	24.8-29	28.5-33.4	46-53.7	47	54	87	

1 Nautical mile = 1852 Meters = 1.1508 Miles

1 Statute mile = 1.609 Kilometres

This indicates that with a handheld VHF, used at sea level, the range will be approx 8 Km (5 Miles). The range will increase if the height above sea level increases, and also if the other user in the other end is at a higher level.



www.jotron.com

9 SPARE PARTS AND ACCESSORIES

P/N	Description
• 99930	Tron TR-20 GMDSS, transceiver only
• 80060	Lithium battery, not rechargeable.
• 80059	NiMH 7.2V, 1500mAh rechargeable battery pack
• 99920	Dual slot fast charger for 80059 batteries.
• 80080	Mains adapter for 99920 EURO style
• 80081	Mains adapter for 99920 UK style
• 80082	Mains adapter for 99920 US style
• 80084	DC cable for 99920 (12 – 24 VDC operation)
• 81719	DC cable for 99920 with cigarette lighter plug
• 84101	Spare antenna
• 80083	Wrist strap
• 80364	Carrier case



www.jotron.com

10 SERVICE AGENTS

Please look at www.jotron.com for Marine Service Agents.

Jotron Group subsidiary companies:

Jotron UK Ltd.

Crosland Park, Cramlington
NE23 1LA
United Kingdom
Tel +44 1670 712000
Fax +44 1670 590265
E-mail: sales@jotron.com

Jotron Asia Pte. Ltd.

Changi Logistics Center
19 Loyang Way #04-26
Singapore 508724
Tel +65 65426350
Fax +65 65429415
E-mail: sales@jotron.com

Jotron USA, Inc.

10645 Richmond Avenue, Suite 170
Houston, TX 77042
USA
Tel +1 713 268 1061
Fax +1 713 268 1062
E-mail: sales@jotron.com



Jotron AS
Jotron UK Ltd.
Jotron Phontech AS
Jotron Consultas AS
Jotron Asia Pte. Ltd.
Jotron USA, Inc.
UAB Jotron



www.jotron.com